

6

5

4

3

2

1



19,5283°

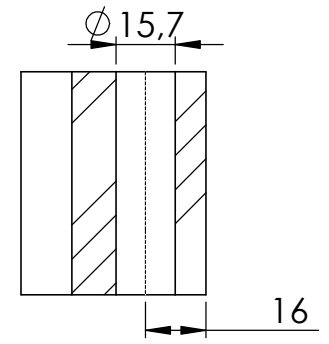
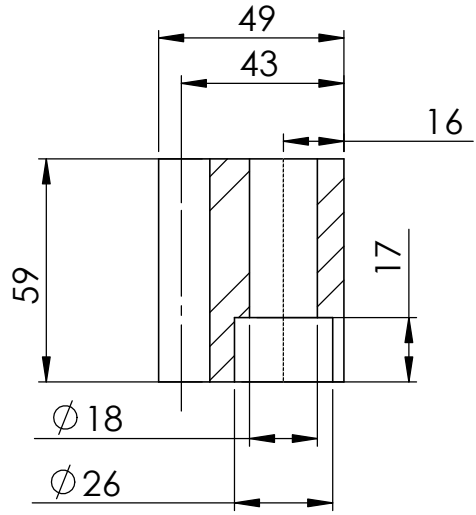

Module : 6
Helix angle (right hand) : 19°31'42"
Tooth hardness : 50-55 HRC
Material : C45
Teeth ground to DIN 7 precision class

Matériau: C45	Masse:	
TITRE: Helical Rack M6-L500-DIN7		
	No. DE PLAN: M6-HA17-500-H1	Echelle: 1:2
		A4
FEUILLE 1 SUR 1		

6

5

4

3

2

1